

Panasonic

CORDLESSPHONE

MODEL NO. **KX-T3826BA**

EASA-PHONE

Pulse-or-tone dialing capability

Operating Instructions



Charge the battery for about 10 hours before initial use.

Please read before use.

Contents

Location of Controls	3
Connection	7
Initial preparation	9
Making calls	11
Answering calls	13
Paging (Intercom)	15
Transferring an incoming call	17
Storing telephone numbers for automatic dialing	18
Automatic dialing	20
Other features	
Temporary tone dialing	21
FLASH button	21
PAUSE button	22
Combination dialing	22
Charging the portable unit	23
Battery replacement	24
Wall mounting	25
Troubleshooting guide	26
Others	26

Location of controls

PORTABLE UNIT

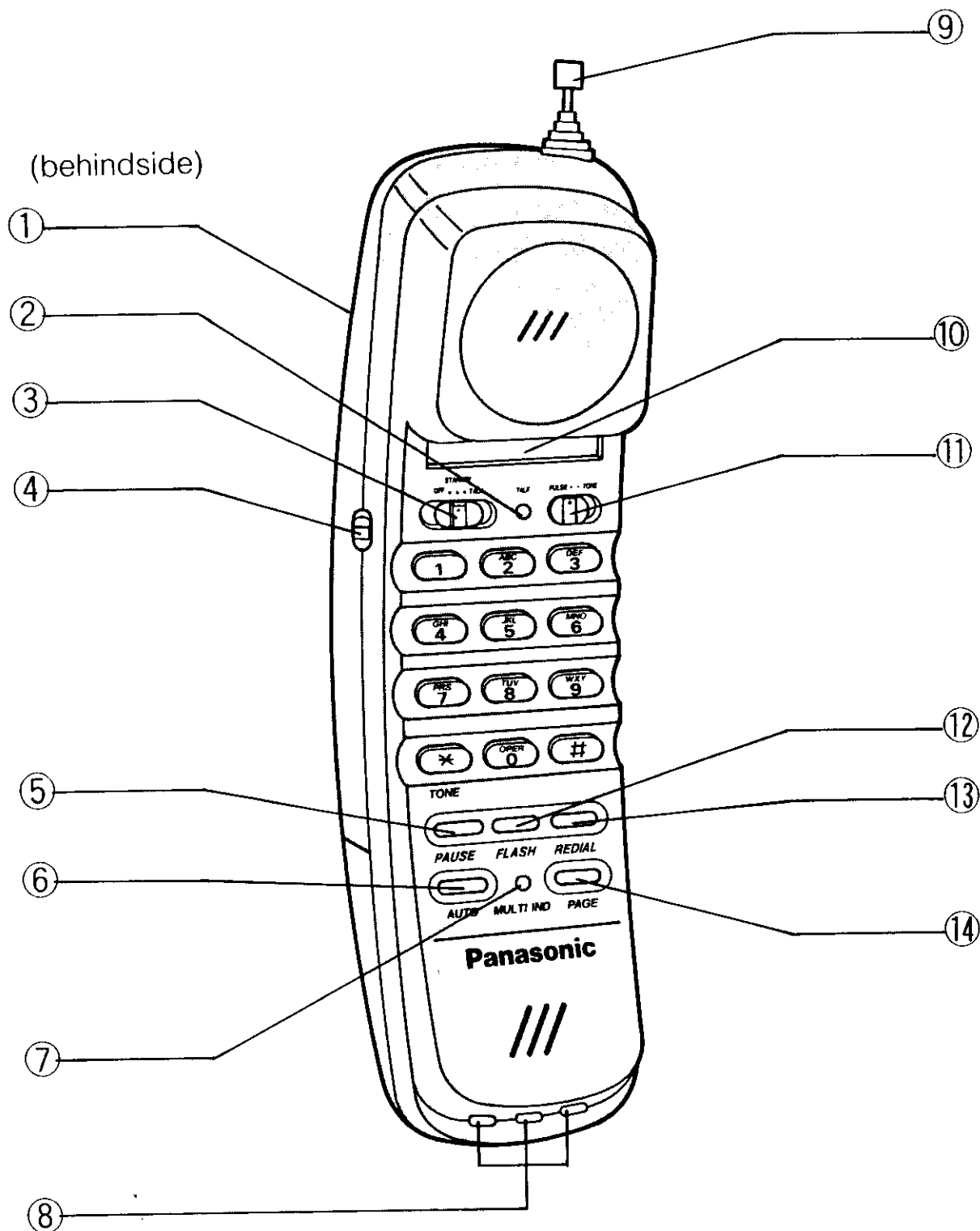

- ①**Memory Card** : Used to write your stored telephone numbers.
- ②**TALK Indicator**
- ③**Function Selector** : Used to turn the unit on and off. See page 10.
- ④**VOLUME Selector** : Used to adjust the volume level of the portable unit. See page 10.
- ⑤**PAUSE Button** : Used to pause during a programming or a dialing operation. See page 22.
- ⑥**AUTO Button** : Used to store the telephone numbers in memory and to dial the stored telephone numbers. See page 18.
- ⑦**MULTI Indicator**
- ⑧**Battery Charge Contacts**
- ⑨**Antenna**
- ⑩**Number Card** : Used to write your telephone number.
- ⑪**DIALING MODE Selector** : Used to select either Pulse or Tone dialing. See page 10.
- ⑫**FLASH Button** : Used to access some features of your host PBX and your telephone company. See page 21.
- ⑬**REDIAL Button** : Used to redial the last dialed telephone number. See page 12.
- ⑭**PAGE Button** : Used to page the base unit. See page 15.

Location of controls

BASE UNIT

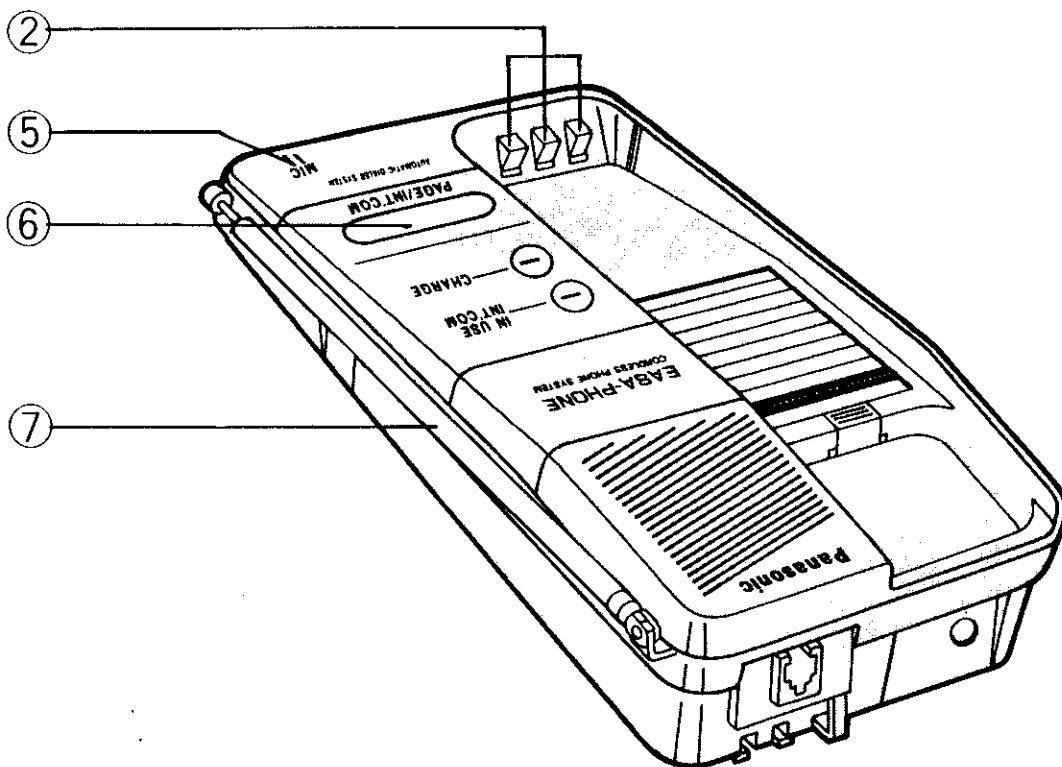
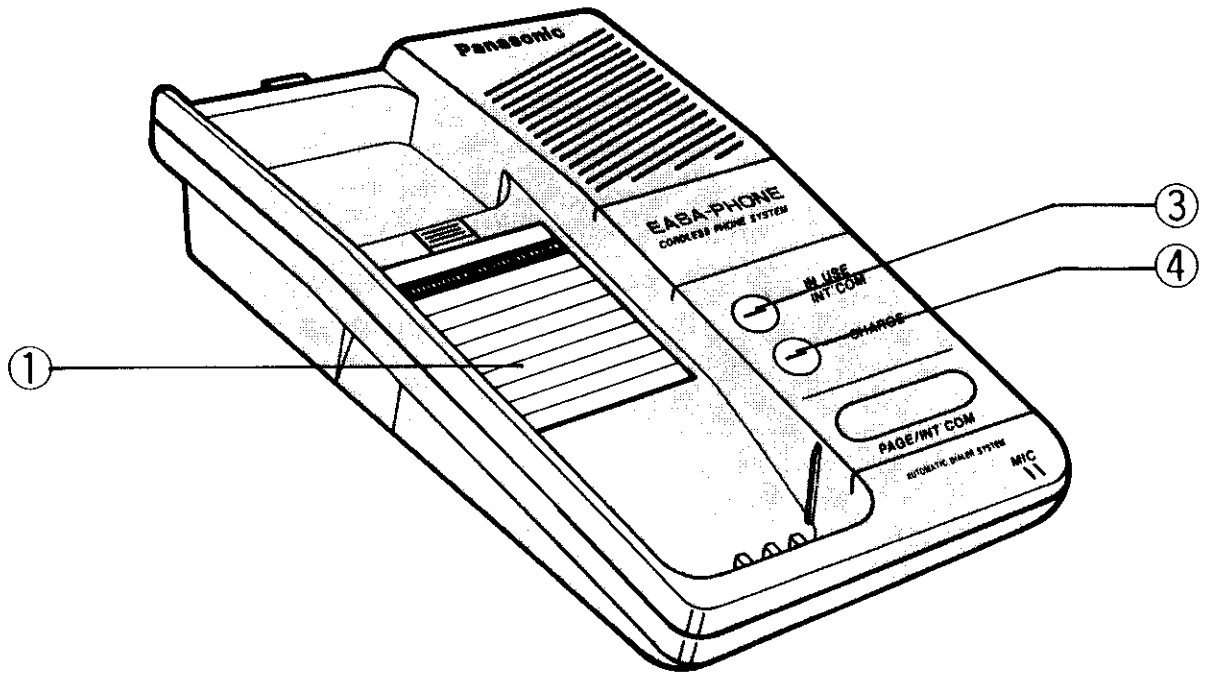

①Memory Card : Used to write your stored telephone number.

②Battery Charge Contacts

③IN USE/INT'COM (intercom) Indicator

④CHARGE Indicator

⑤MIC (microphone)

⑥PAGE/INT'COM (intercom) Button : Used to page the portable unit. See page 15.

⑦Antenna

Connection

Connect the unit with the telephone line and the AC Adaptor.

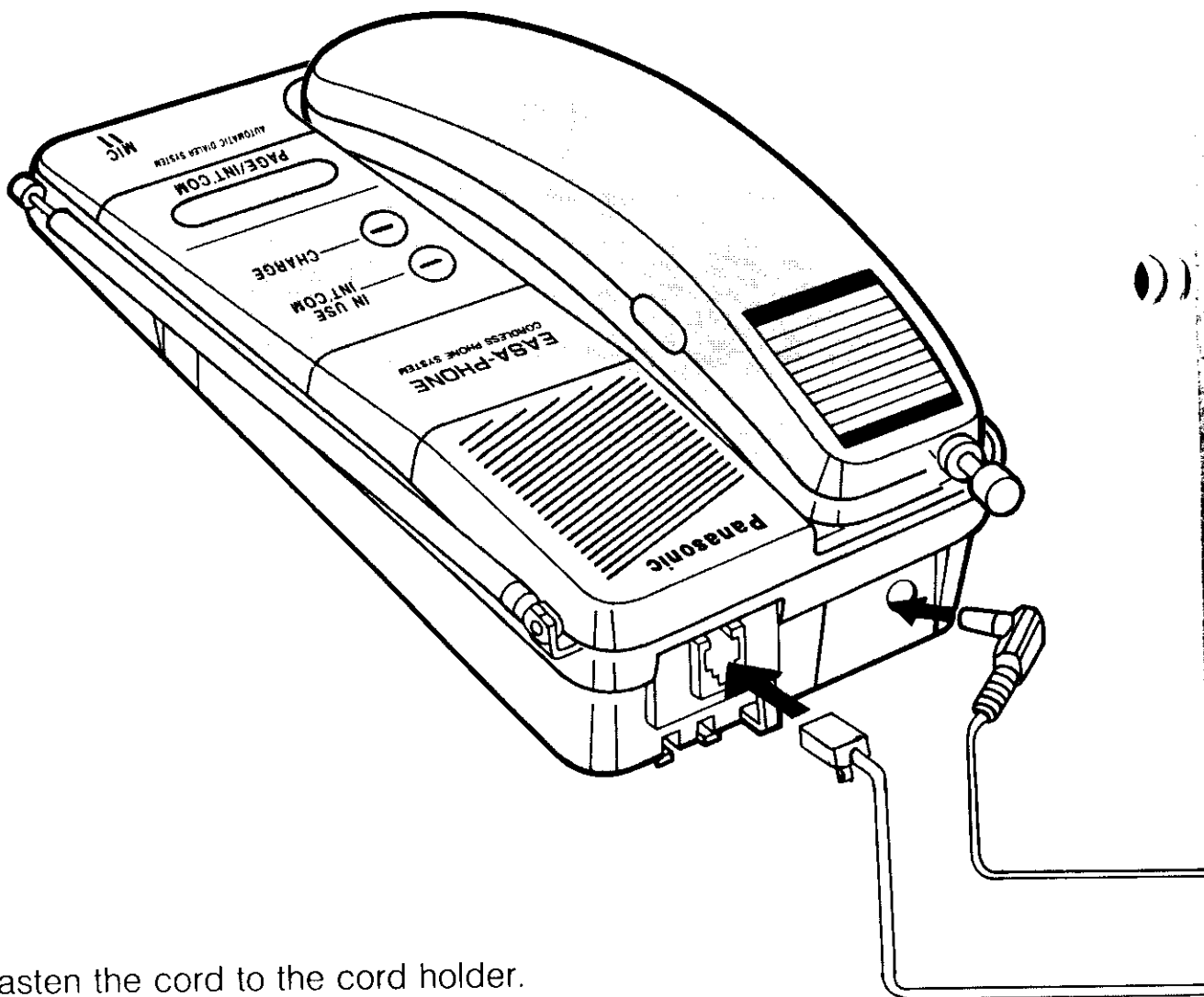

Fasten the cord to the cord holder.

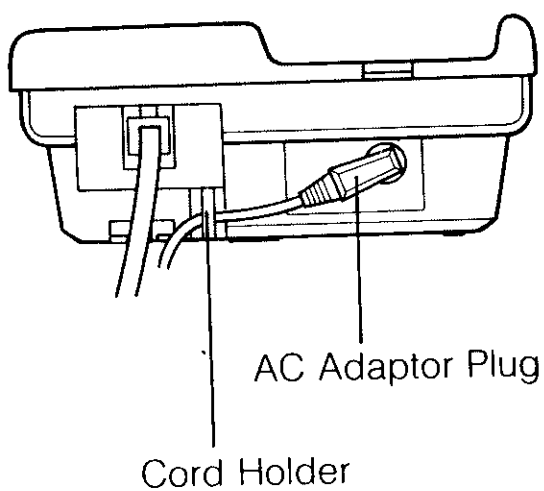

To connect another telephone on the same line, please use T-Adaptor.

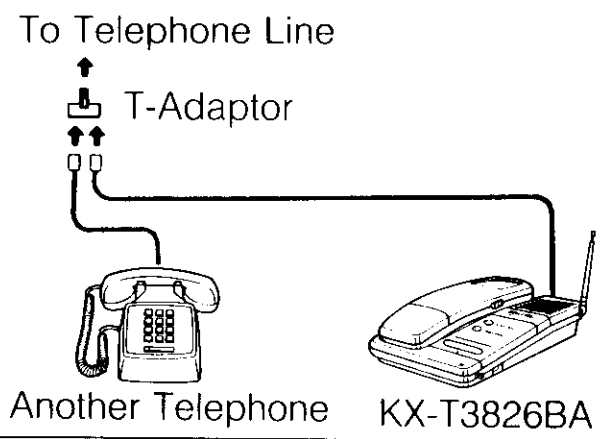

- 1 Charge the battery about 10 hours by placing the portable unit on the cradle. See page 23.
- 2 Extend the antennas fully for the best performance.
 - The possible calling distance may vary depending on length of the antennas extended.

Use only Panasonic AC Adaptor, KX-A10BA.

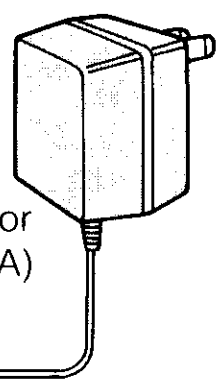

To Power Outlet (AC 240V, 50Hz)

AC Adaptor (KX-A10BA)

Telephone Line Cord

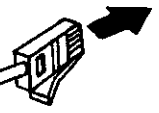

To telephone line

Accessories

● Telephone Line Cord one

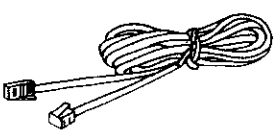

● AC Adaptor one

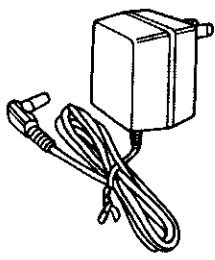

● Wall-mounting adaptor one

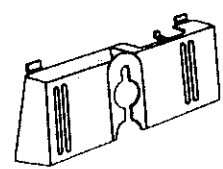

● Screws two
Washers two

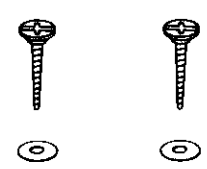

Initial preparation

Charge the portable unit for about 10 hours before initial use.

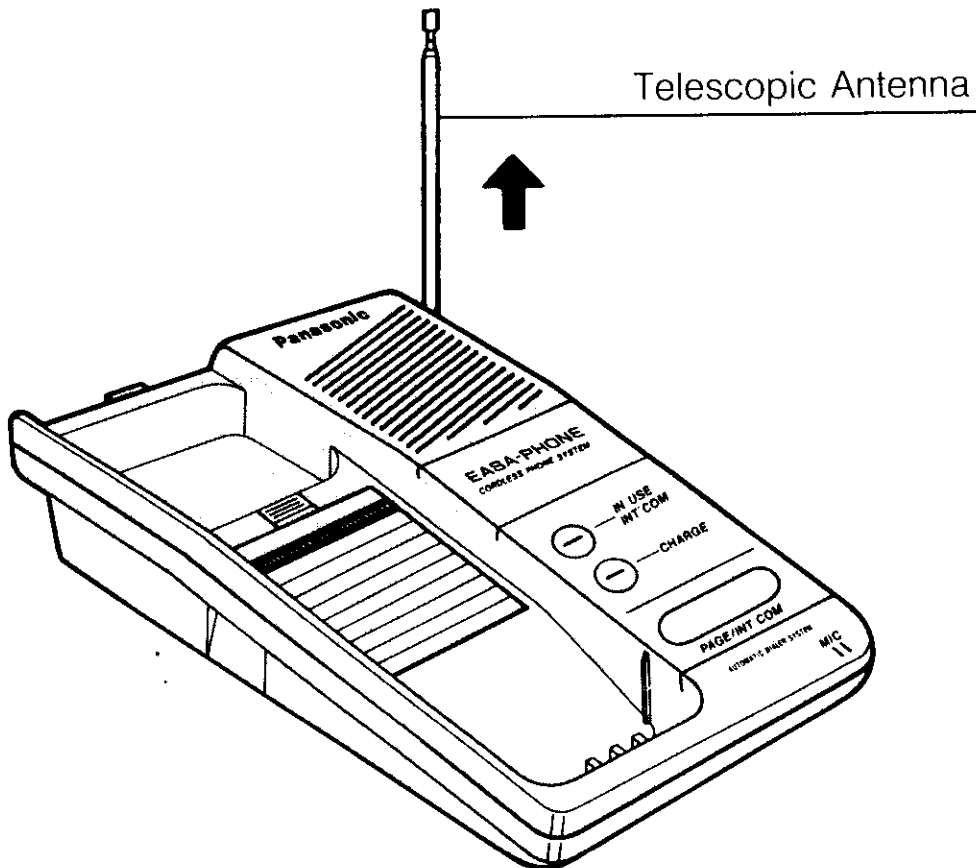
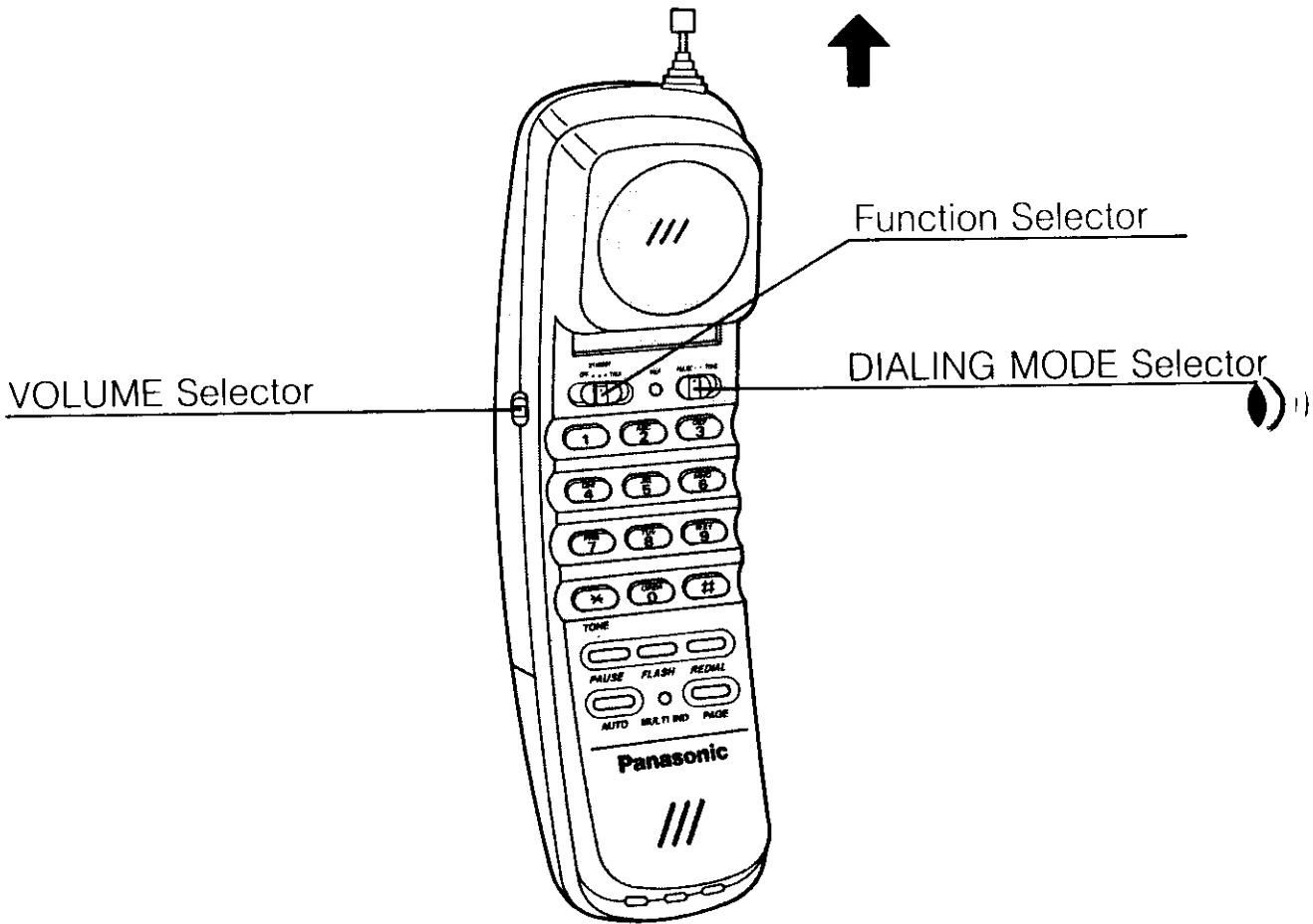

Note: Extend the Telescopic Antenna for best performance.

1

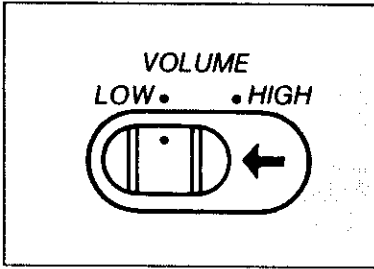

VOLUME Selector:

Set the VOLUME selector to the "LOW" position.

When the other party's voice is difficult to hear, set the selector to the "HIGH" position.

2

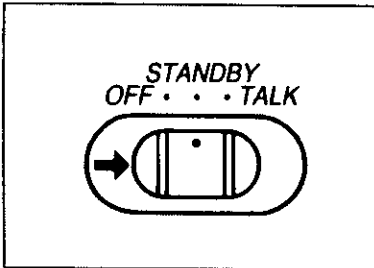

Function Selector:

Set the function selector to the "STANDBY" position.

- When you do not want the telephone to ring, set the function selector to the "OFF" position.
- If you do not use the unit for a long time, set the function selector to the "OFF" position.

3

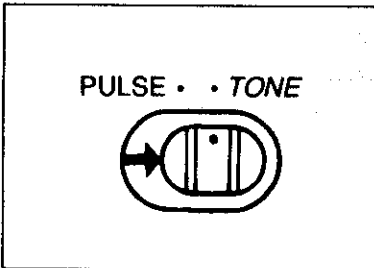

DIALING MODE Selector:

Set the DIALING MODE Selector on the portable unit to the "TONE" position if your telephone line has touch tone service. If it has rotary dial pulse service, set the selector to the "PULSE" position.

4

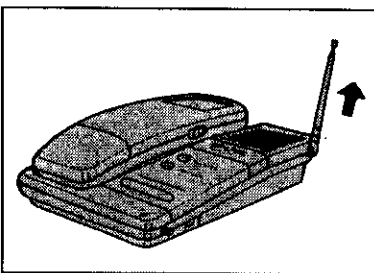

Telescopic Antenna:

Extend the Telescopic Antenna of the base unit fully and vertically for the best performance.

Making calls

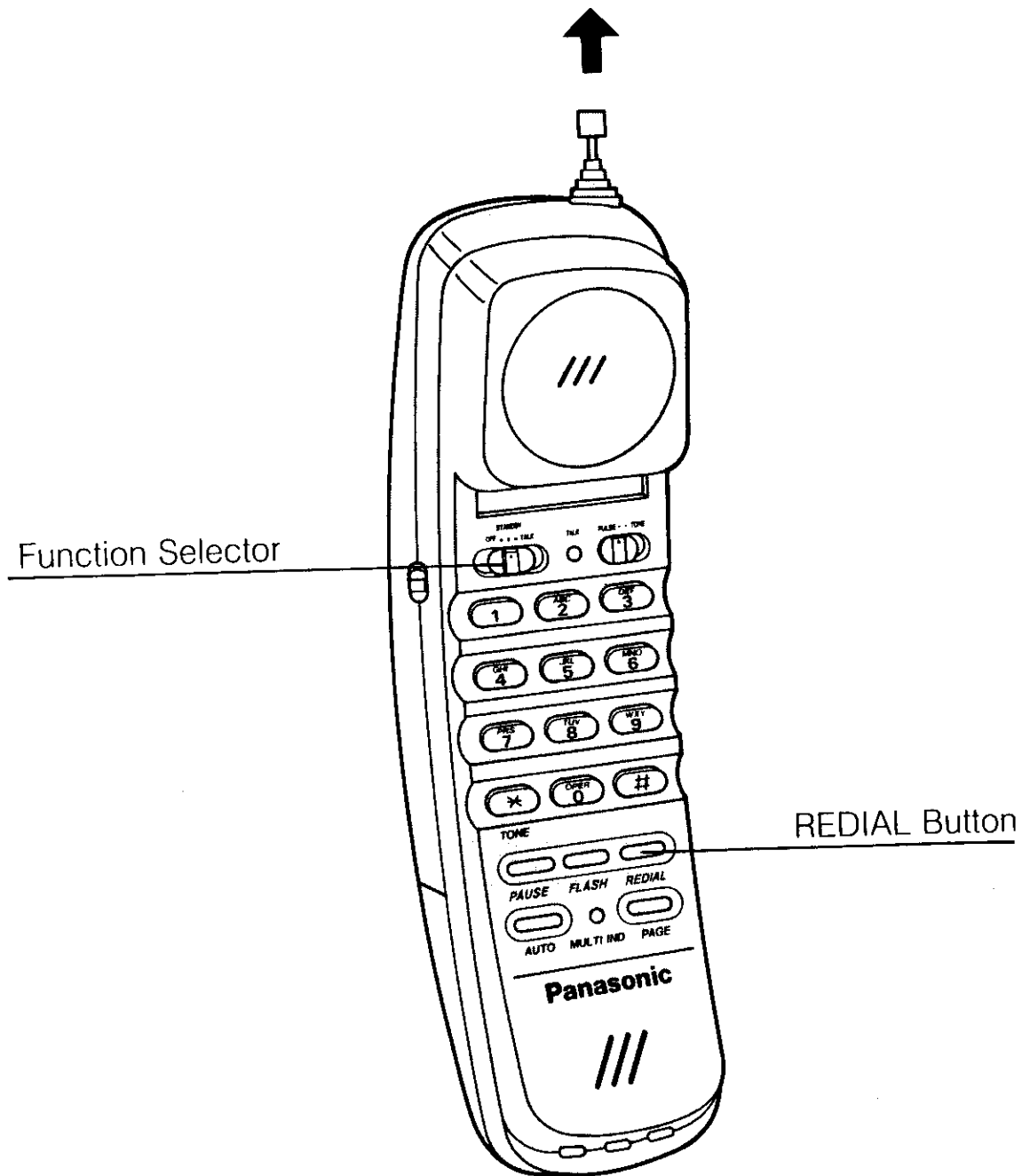

Note: Extend the Telescopic Antenna for the best performance.

1

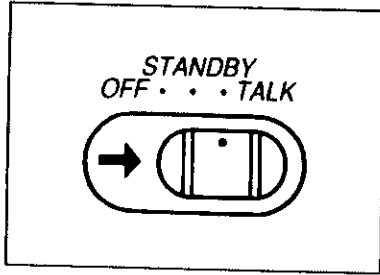

Set the function selector to the "TALK" position.

The TALK indicator light is on.

2

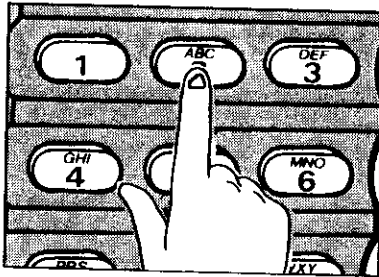

Dial the telephone number.

3

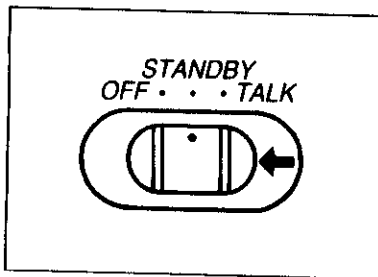

When your conversation is over, set the function selector to the "STANDBY" position.

The TALK indicator light goes out.

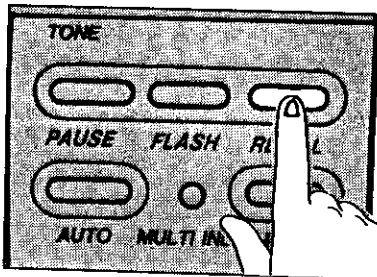

■ Using the REDIAL button,

The unit can redial the last dialed number.

Pressing the REDIAL button enables you to redial once.

Answering calls

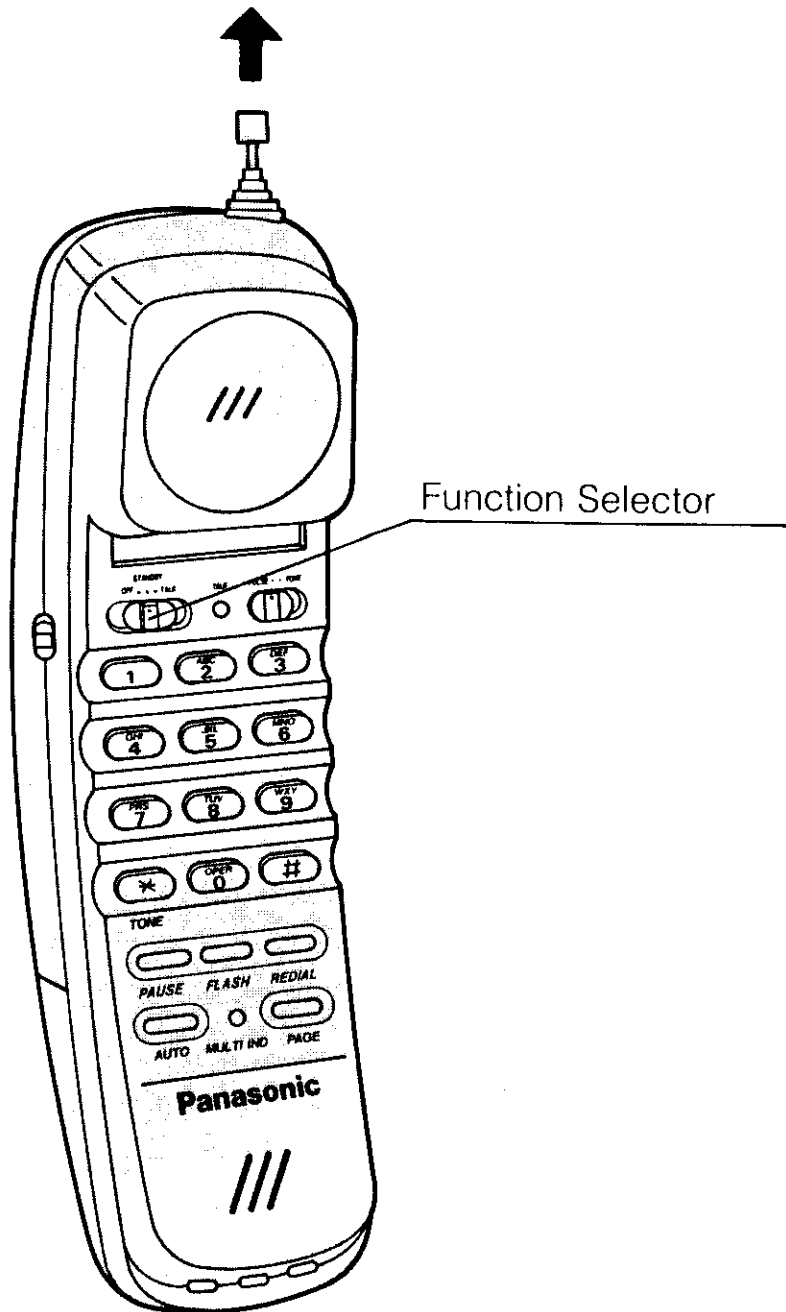

Note: Extend the Telescopic Antenna for best performance.

Be sure that the function selector is set to "STANDBY" position.

1

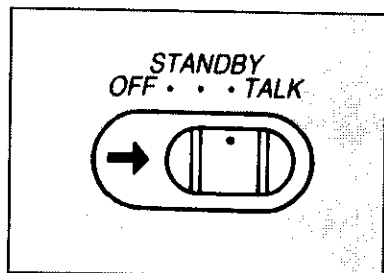

When the telephone rings, set the function selector to the "TALK" position and answer the call.

The TALK indicator light is on.

2

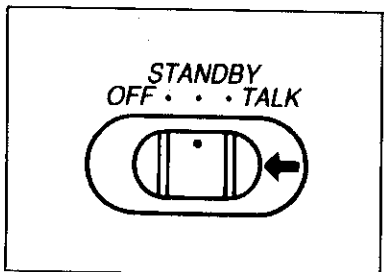

When your conversation is over; Set the function selector to the "STANDBY" position.

The TALK indicator light goes out.

Paging (Intercom)

You can use the unit for two-way intercom between the portable unit and base unit.

Paging from the base unit

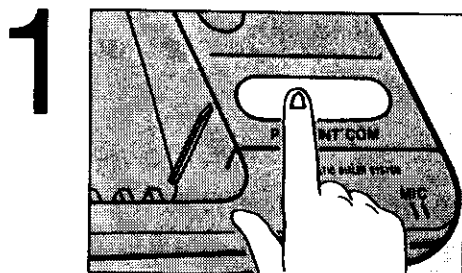

The base unit user:

Press the PAGE/INT'COM button on the base unit.

The IN USE/INT'COM indicator flashes and the base unit beeps.

- If the portable unit user does not answer your paging, press the PAGE/INT'COM button once again to stop the paging.

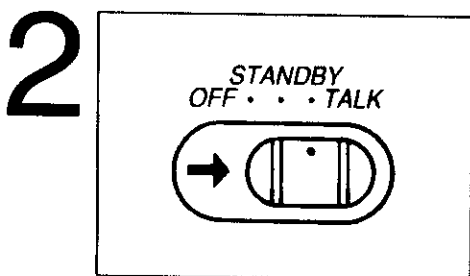

The portable unit user:

When the beep sounds, set the function selector to the "TALK" position to answer the paging.

The TALK indicator light is on.

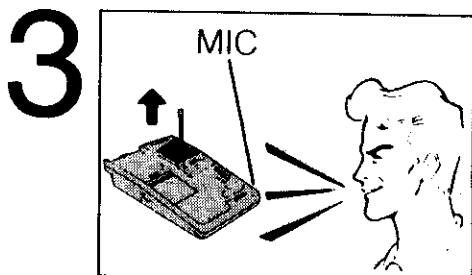

The base unit user:

Speak to the paged party through the MIC.

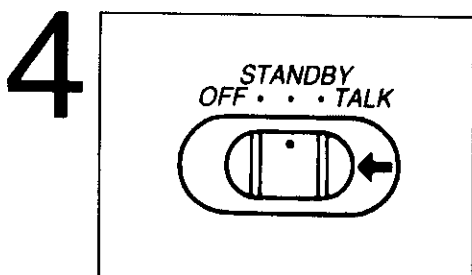

The portable unit user:

When your conversation is over, set the function selector to the "STANDBY" position to hang up.

- Intercom call can be terminated by the portable unit user only.

Paging from the portable unit

Be sure that the function selector is set to the "STANDBY" position.

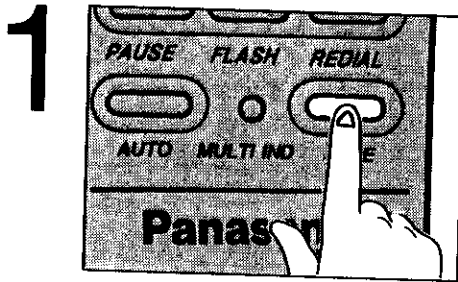

The portable unit user:

Press the PAGE button.
The TALK indicator light flashes and the portable unit beeps.

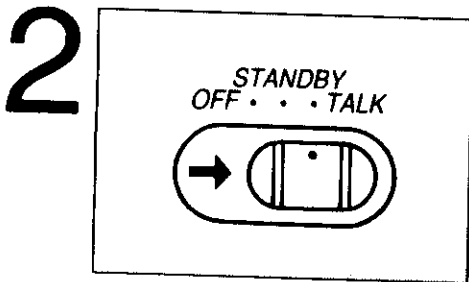

Set to the function selector the "TALK" position to speak the base unit user.
The TALK indicator light changes from flashing to a steady light, and the Intercom call is automatically established.

● If no answer, press the PAGE button to step Intercom mode.

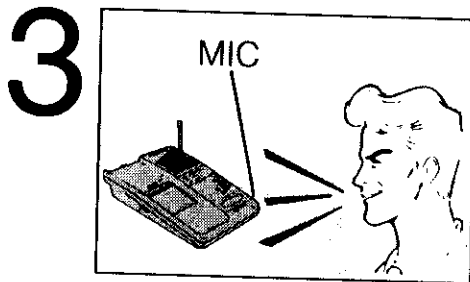

The base unit user:

When the beep sounds, the IN USE/INT'COM indicator turns to a steady light from flashing, then speak to the paging party through the MIC.

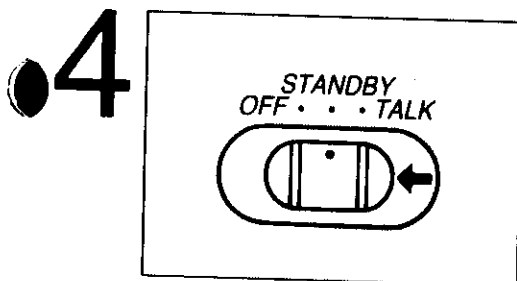

The portable unit user:

When your conversation is over, set the function selector to the "STANDBY" position.

● Intercom call can be terminated by the portable unit user only.

Transferring an incoming call

The base unit user will be able to receive a call and transfer it to the portable unit. This is done by connecting another telephone on the same line to the base unit with the T-Adaptor.

Transferring from the base unit to the portable unit

1 The base unit user:

Pick up the handset of another telephone connected on the same line to the base unit to answer the incoming call.

2

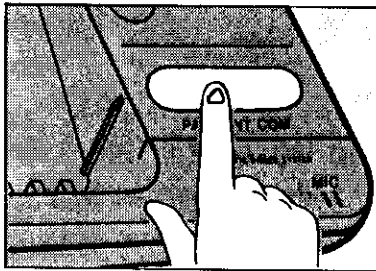

Press the PAGE/INT'COM button, to page the portable unit user.

3

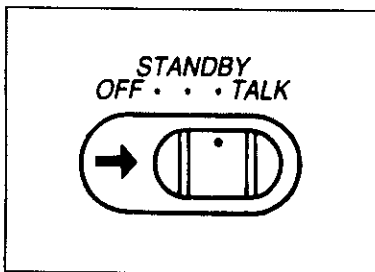

The portable unit user

When the beep sounds, set the function selector to the "TALK" position to answer the page.

For a three way conversation, keep the handset off-hook.

4

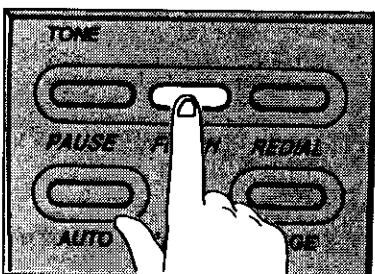

Press the FLASH button to answer the incoming call.

5

The base unit user:

After confirming a portable unit user answers the call, another telephone may hang up.

6

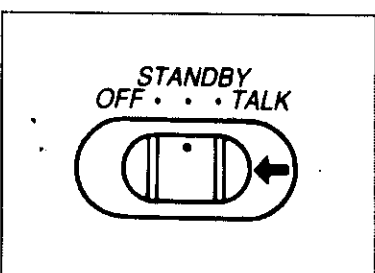

The portable unit user:

When your conversation is over, set the function selector to the "STANDBY" position to hang up.

The TALK indicator light goes out.

Storing telephone numbers for automatic dialing

Each dialing button (1 through 9) serves as a memory station for automatic dialing.

Each station is capable of storing a 16-digits number.

Storage

1

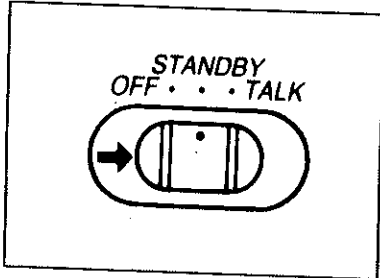

Set the function selector to the "STANDBY" position.

2

Press the station number (1 through 9) while pressing the Auto button at the same time.

The MULTI indicator light is on.

3

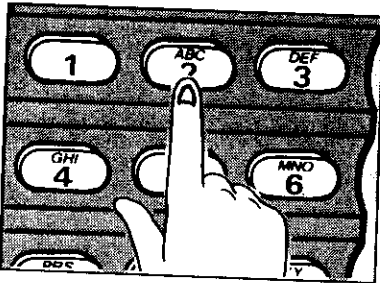

Enter the telephone number (up to 16 digits).

4

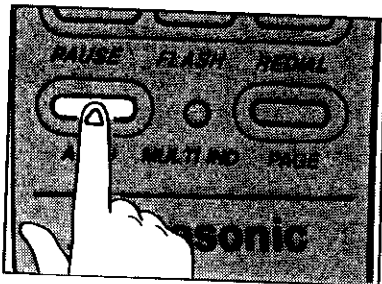

Press the AUTO button.

The MULTI indicator light goes out.

- Repeat step 2 through 4 to store other telephone numbers in the other stations.

Note:

- If you do not press a dialing button within 30 seconds while programming, programming mode is then canceled. Reprogramming is necessary.
- Even while storing, you may receive a call. If you do, simply press the TALK button. Programming is then canceled and reprogramming is necessary.

Correcting an error while storing

1

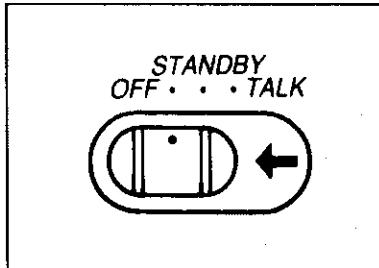

Set the function selector to the "OFF" position.

- The new entry is cleared and the previous stored number remains untouched.

2

Repeat "Storage" on page 18.

Confirming a stored number

Enter the same number into the same station.

When you press the AUTO button, a confirmation tone sounds.

- twice:

The entry is the same as what was previously stored.

- once:

The entry is different from the one that was previously stored.

Erasing a stored number

Example: Erasing a telephone number stored in memory station [2].

1

Set the function selector to the "STANDBY" position.

2

Press the AUTO button and the station number [2] simultaneously.

3

Press the AUTO button to complete the erasure.

Automatic dialing

Before using Automatic dialing, you must store the telephone number.

1

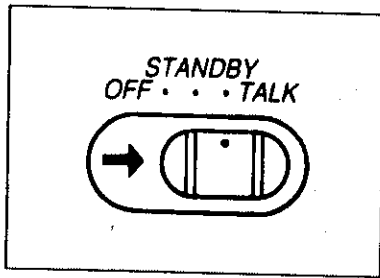

Set the function selector to the "TALK" position.

The Talk indicator light is on.

2

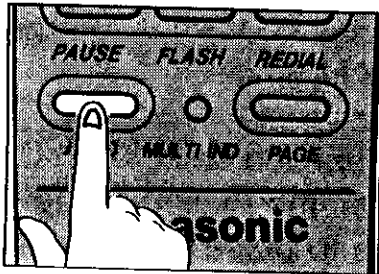

Press the AUTO button.

3

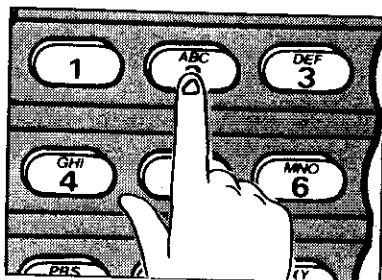

Press the station number where the telephone number that you want to dial is stored.

The stored number is automatically dialed.

4

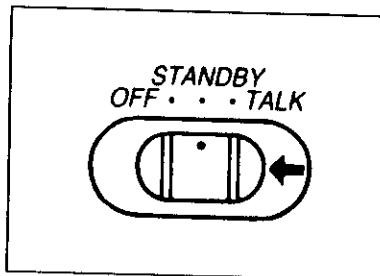

When your conversation is over, set the function selector to the "STANDBY" position.

Other features

Temporary tone dialing

Use the TONE button (✖) when your line has rotary telephone service. Pressing it will allow you to change the dialing mode from pulse to tone during a dialing operation, and enter special tones and codes to operate answering machine, electronic banking services and other special services.

"TONE" can be programmed into memory stations with the telephone numbers.

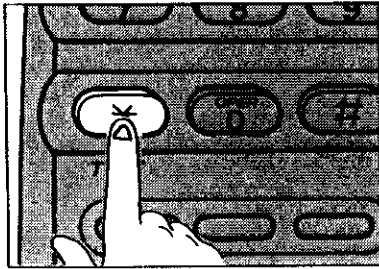

Press the TONE (✖) button.

When you set the function selector to the "STANDBY" position, the dialing mode will automatically return to pulse mode.

FLASH button

The FLASH button is used to access special telephone services such as call waiting and call forwarding.

For further details, please see a brochure issued by your telephone company.

- 1 While having a conversation, another party calls and tone is heard.
 - 2 Press the FLASH button.
 - The first conversation is placed on hold and the second call can be answered.
 - 3 When you finish your conversation with another party press the FLASH button again.
 - The first caller can be spoken to again and the second call is placed on hold.
- "FLASH" can be stored into memory in the same way as "Storage" on page 18.
 - You may access some features of your host PBX using the FLASH button in a dialing operation.

PAUSE button

The PAUSE button is used in a dialing sequence to access an outside line.

■ Using the PAUSE button

When the unit is connected to your PBX's extension, enter the line access number and a pause to access an outside line.

Also when redialing, a pause may be required by your host PBX.

Example: If the line access number is "9", press "9" and the PAUSE button. Then dial the telephone number.

9 — PAUSE — Phone Number

Combination dialing

The following combinations of dialing methods can be used.

- Manual dialing and automatic dialing
- Pulse and Tone dialing
- Plural memory stations

Charging the portable unit

Charge the battery of the portable unit for about 10 hours before initial use, or if the MULTI indicator on the portable unit flashes.

Place the portable unit on the cradle.

The CHARGE indicator light is on.

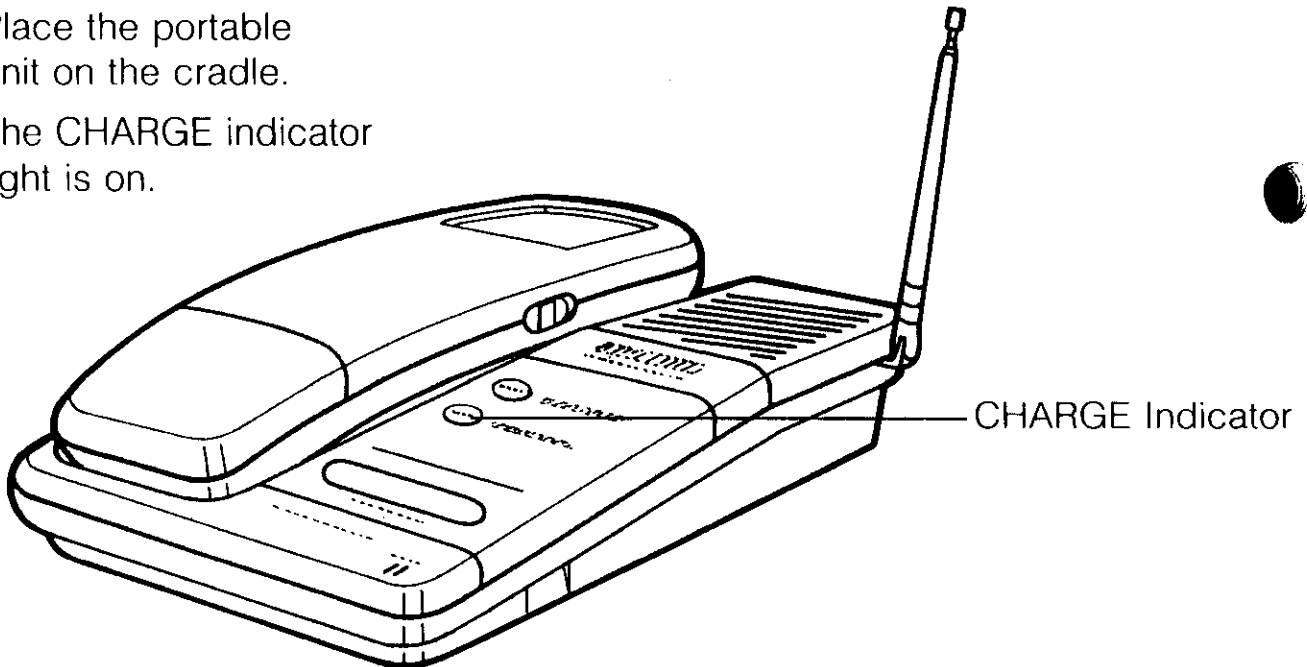

You can use the unit before 10 hours are up. But be sure to put the portable unit on the cradle so it can continue charging.

Note:

- Even when the MULTI indicator flashes, the portable unit will still function for a short period of time.
- Recharging is required after a long interval, as the unit will consume some battery power gradually when not being on the cradle while in the "STANDBY" mode. If you will not use the unit for a long period of time, set the function selector to the "OFF" position.
- Clean the battery charge contacts with a soft cloth about once a month, otherwise the portable unit may not be charged properly.

Battery replacement

If the MULTI indicator flashes after a few telephone calls even when the battery has been charged for 10 hours, replace it.

1

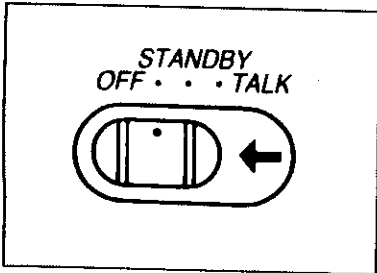

Be sure that the function selector is set to the "OFF" position.

2

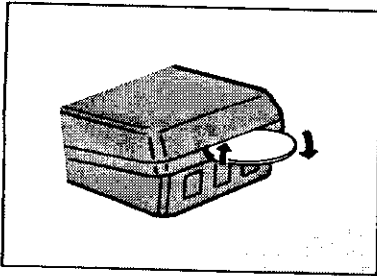

Remove the battery compartment cover using an object such as a coin.

3

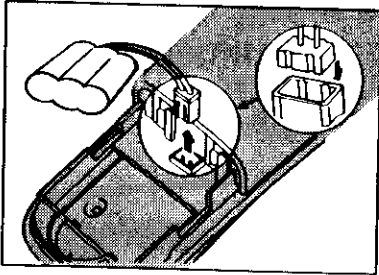

Replace the battery.

Note:

- Please use only Panasonic KX-A36A.
- Remember to charge the battery for 10 hours.

Wall mounting

This unit can be mounted on the wall utilizing the washers and screws provided.

1. Turn over the handset guide.

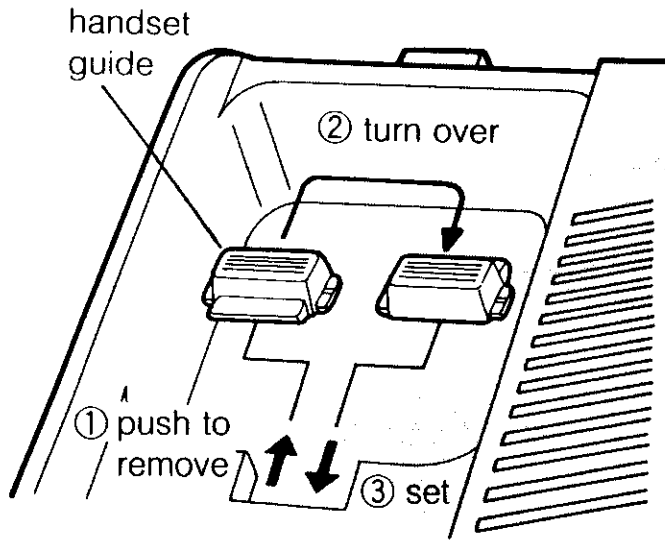

2. Insert the hook of the wall mounting adaptor into the hole of the unit then push it in the direction of arrow (A) as shown.

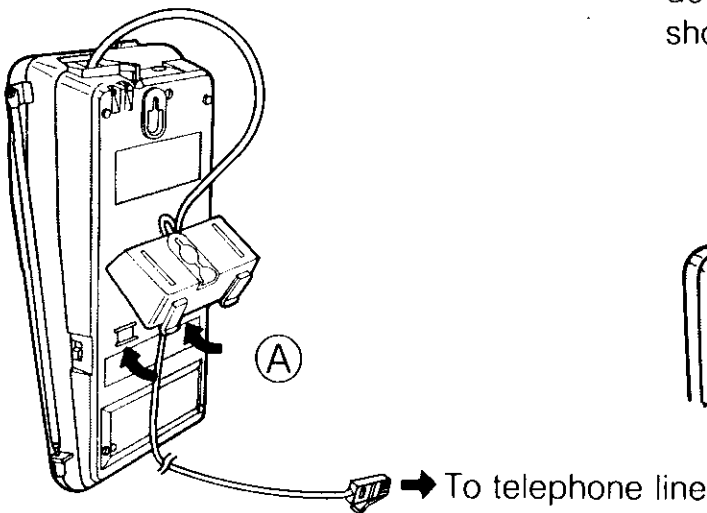

3. Using the washers fix the screws to the wall in the positions indicated.

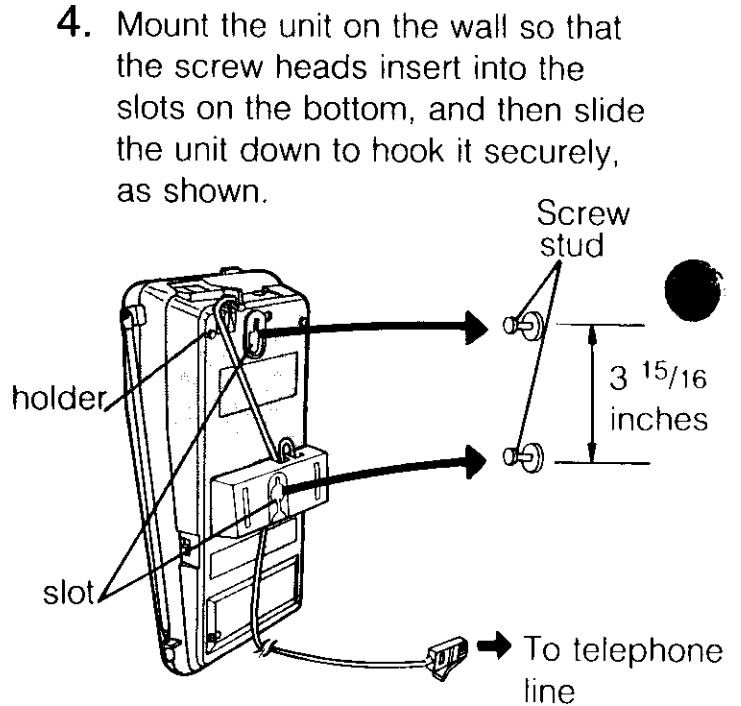

- To temporarily place the handset down during a conversation, hook as shown.

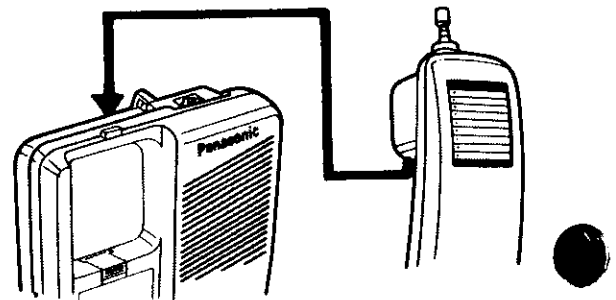

Wall Template

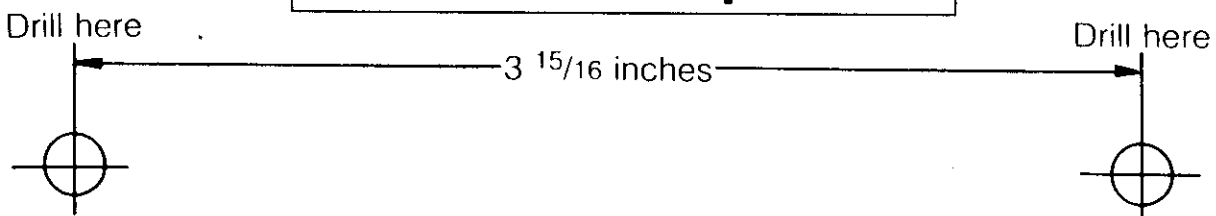

Troubleshooting Guide

The unit does not work.

The battery is in need of charging.
The AC Adaptor is not plugged into an outlet.
No telephone line connection is made.
The telephone line connection is made improperly.

Dial Tone is not heard.

See the above-mentioned possible causes.
You are too far from the base unit. Move closer to base unit.
Set the function selector to the "STANDBY" position then set it to the "TALK" position.

The portable unit does not ring.

Make sure the function selector is set to the "STANDBY" position.

Sound flutters or fades.

You are too far from the base unit. Move closer to base unit.
The telescopic antennas are not fully extended.

I charged the battery for 10 hours, but the MULTI indicator flashes after a few telephone call.

It is time to change the battery.
Please replace.

While operating the unit the AC adaptor feels warm.

This is normal.

● Others

- If there is any trouble, disconnect the unit from the telephone line and connect a known working telephone. If the known working telephone operates properly return your unit to your supplier for repair, if the known working telephone does not operate properly, consult with a telephone company.

WARNING:

TO PREVENT FIRE OR SHOCK HAZARD, DO NOT EXPOSE THIS PRODUCT TO RAIN OR ANY TYPE OF MOISTURE.

When a failure occurs which results in the internal parts becoming accessible, disconnect AC adaptor immediately and return this unit to service center.